

e

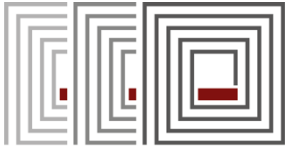

**KTS**SYSTEME

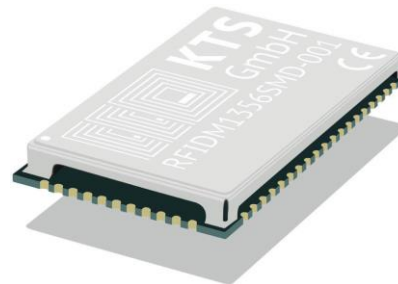

## SMD Micro-Module

### RFIDM1356SMD-001

The KTS SMD Micro-Module is a fully integrated SMD-solderable RFID transceiver module. At just 12x20mm, smaller than most postage stamps, this module contains both a full-fledged microcontroller and a high performance RFID transceiver IC, combined with the proven, robust KTS RFID embedded software stack - perfect for efficient implementation of RFID functionality in both existing and new applications.

The RFID transceiver includes a powerful RF front-end with up to +23dBm (200mW) of output power into a matched 50Ω antenna feed, along with a dual channel receiver for improved reading performance. Out of the box, the Micro-Module supports ISO15693 and ISO14443A/B, with additional modes such as NFC tag emulation available upon request.

Due to the flexibility the dedicated onboard communications-and-control microprocessor affords, the Micro-Module can communicate over a variety of interfaces, from custom GPIO mappings to serial UART, and on to a full USB 2.0 interface. In addition, custom interfaces are available on demand, allowing the Micro-Module to work in conjunction with additional communications modules, easing integration into wireless communication systems as well as custom bus systems.

The integrated microcontroller can also be used as a fully capable application controller, reducing the need for additional system components. This also allows the Micro-Module to act as a control unit for multiplexed antenna arrays, allowing readers with multiple antennas to be designed and implemented quickly and efficiently.

KTS provides a substantial support package for the SMD Micro-Module, including EDA component files, extensive implementation information and software packages for management and configuration. We also offer design and development services for integration of the Micro-Module into existing and future projects on both hardware and software fronts.

# Technical Specifications

## Technical Specifications

<b>Product type</b>	Integrated RFID Micro-Module for SMD placement
<b>Operating frequency</b>	13.56 MHz
<b>Antenna connection</b>	Single-ended 50Ω direct solder connection – external balun circuit available if required
<b>RF output power</b>	Up to +23dBm / 200mW
<b>Power supply</b>	3.3V or 5V DC
<b>Power consumption</b>	120mA avg. in Active mode, 10mA avg. in Low Power Mode
<b>RFID standard support</b>	ISO 15693, ISO14443A/B
<b>Anticollision</b>	Supported
<b>Standard host interfaces</b>	USB 2.0, UART w/ HW flow control
<b>Standard control interfaces</b>	Antenna multiplexer control (Direct GPIO mapping, Shift Register Multiplexing or custom multiplexer designs for up to 96 antennas)
<b>USB connection modes</b>	HID virtual keyboard mode CDC virtual serial port mode
<b>CDC instruction set</b>	Extensive AT-style command set for scanning, reading and writing tags as well as configuration
<b>Product certifications</b>	Pending RED certification, CE
<b>RF shield</b>	Optional laser-etched Board Level Shield (Shown on Pg. 1)
<b>Dimensions</b>	20 x 12 x 2.5 mm [LxWxH] / 20 x 12 x 3.5mm [LxWxH with RF Shield]
<b>Weight</b>	1.5g / 5g with RF Shield
<b>Order number</b>	RFIDM1356SMD-001

## Typical Applications

- USB RFID Readers
- Multiplexed RFID antenna arrays
- Wireless RFID readers
- High volume minimal-footprint RFID solutions

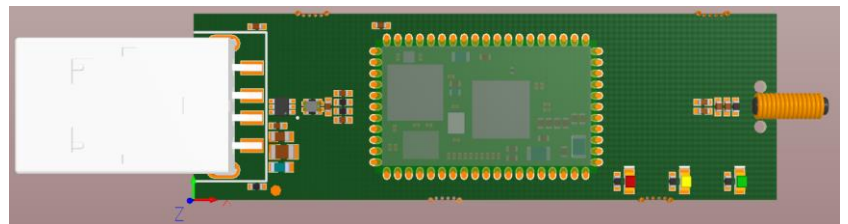

Figure 1: Simple USB reader with integrated antenna

# Pin Descriptions



Figure 2: Module pinout

Pin Description			
Pin	Function	Description	Parameters & Add. Info
1	GND	PWR GND	Always connect this pin to GND
2	RSVD	Reserved for future use	Leave floating - Do not tie to GND
3	RSVD	Reserved for future use	Leave floating - Do not tie to GND
4	GND	USB GND pin	Electrically equivalent to Standard GND, located close to USB for use in simple USB applications
5	USB-P	P-Side of USB Differential Signal	Use with Pin 4 and Pin 7 for simple USB reader
6	USB-N	N-Side of USB Differential Signal	Use with Pin 4 and Pin 7 for simple USB reader
7	LDO_IN_5V	5V input for on-board LDO	Electrically equivalent to 5VDC Input (Pin 60)
8	GND	Standard GND	
9	VATSAM_RESET	Reset signal for Microcontroller	Active Low reset pin, 10kΩ Pullup to 3.3V optional
10	EXTINT	External Interrupt pin for Microcontroller	Active High interrupt pin
11	USB-SOF-1KHZ	USB Start-of-Frame synchronization signal	Leave floating if unused
12	SWCLK	Two-Wire Debug (Clock)	Compatible with standard Atmel debugging tools
13	SWDIO	Two-Wire Debug (Data)	Compatible with standard Atmel debugging tools
14	GND	Standard GND	
15	GPIO_EXT_1.1	Standard GPIO	
16	GPIO_EXT_1.2	Standard GPIO	
17	GPIO_EXT_1.3	Standard GPIO	
18	GPIO_EXT_1.4	Standard GPIO	
19	GND	Standard GND	
20	L_RCLK	Proprietary Shift Register Multiplexing Port	
21	L_INP	Proprietary Shift Register Multiplexing Port	
22	L_OUT	Proprietary Shift Register Multiplexing Port	
23	L_SCK	Proprietary Shift Register Multiplexing Port	
24	GND	Standard GND	
25	RSVD	Reserved for future use	Leave floating - Do not tie to GND
26	GND	Standard GND	

kts\_db\_name\_20170000\_d

27	RSVD	Reserved for future use	Leave floating - Do not tie to GND
28	GND	Standard GND	
29	RSVD	Reserved for future use	Leave floating - Do not tie to GND
30	GND	Standard GND	
31	GND	Standard GND	
32	RSVD	Reserved for future use	Leave floating - Do not tie to GND
33	GND	Standard GND	
34	RSVD	Reserved for future use	Leave floating - Do not tie to GND
35	GND	HF GND	Always connect this pin to GND
36	EXT_RF_50OHM	50Ω RFID Signal	Single-Ended
37	GND	HF GND	Always connect this pin to GND
38	RSVD	Reserved for future use	Leave floating - Do not tie to GND
39	GND	Standard GND	
40	RSVD	Reserved for future use	Leave floating - Do not tie to GND
41	GND	Standard GND	
42	RSVD	Reserved for future use	Leave floating - Do not tie to GND
43	RSVD	Reserved for future use	Leave floating - Do not tie to GND
44	GND	Standard GND	
45	RSVD	Reserved for future use	Leave floating or tie to GND
46	RSVD	Reserved for future use	Leave floating or tie to GND
47	GND	Standard GND	
48	TXD0	UART TXD	UART serial data TX (module out)
49	RXD0	UART RXD	UART serial data RX (module in)
50	RTS0	UART RTS	UART Request-To-Send (module out) – Optional, leave floating if unused
51	CTS0	UART CTS	UART Clear-To-Send (module in) – Optional, leave floating if unused
52	GND	Standard GND	
53	LED_DATA	Data LED output - Lights to show data transfer activity	3.3V output, connect to LED with appropriate current limiting resistor. Max. drive current 5mA.
54	LED_TAG	Tag LED output - Lights to show tag detection activity	3.3V output, connect to LED with appropriate current limiting resistor. Max. drive current 5mA.
55	LED_RUN	Run LED - Lights to show module is running	3.3V output, connect to LED with appropriate current limiting resistor. Max. drive current 5mA.
56	GND	PWR GND	Always connect this pin to GND
57	V_IN_TRF	RFID Transceiver analog frontend supply voltage	Connect to 5VDC for 200/100mW RF output power or to 3.3VDC for 70mW/33mW output power (setting in combination with output power register)
58	LDO_OUT_3.3V	3.3V on-board LDO output	For connection to V_IN_TRF (Pin 57), V_IN_3.3V (Pin 59) and/or external devices. Max. Load for external devices: 100mA
59	V_IN_3.3V	Microcontroller & Transceiver Digital Section supply voltage	Connect to LDO_OUT_3.3V (Pin 58) or external 3.3VDC supply
60	LDO_IN_5V	5V input for on-board LDO	Connect to 5VDC if using on-board LDO

# Design & Implementation

## RF Output

The Micro-Module provides a single-ended antenna connection on Pin 36 (*EXT\_RF\_50OHM*). Connect this pin to a impedance-controlled 50Ω trace for optimal performance. Pins 35 and 37 (HF GND pins) should always be connected to GND for optimal performance.

The RF front-end allows four different settings for adjusting the TX power output to suit application requirements. These are controlled by two factors:

1. The voltage supplied to the RF front-end analog section via Pin 57 (*V\_IN\_TRF*)
2. The programmable TX Power Config Flag

Power Output		TX Power Config Flag	
RF Power	Analog Front-End Supply Voltage	High Power Mode	Low Power Mode
Full-Power RF mode	5 V	+23dBm / 200mW	+18.45dBm / 70mW
Reduced-Power RF mode	3.3 V	+20dBm / 100mW	+15.19dBm / 33mW

As shown in the table above, connecting Pin 57 (*V\_IN\_TRF*) to a 5V source allows the designer to choose between 200mW or 70mW output levels via the TX Power Config Flag. Respectively, connecting Pin 57 (*V\_IN\_TRF*) to a 3.3V source allows a choice between 100mW and 33mW output levels.

KTS recommends, as standard practice, using 0Ω jumper resistors to allow switching between Full-Power and Reduced Power RF modes without requiring a PCB respin.

## RF PCB Traces

As soon as the PCB design allows, any PCB trace connected to Pin 36 (*EXT\_RF\_50OHM*) should be impedance controlled, ideally as close to 50Ω as possible for optimal performance. Large deviations from this recommendation can result in severely reduced RF performance as well as EMI issues.

The RF traces should be routed over an uninterrupted, unhatched ground reference such as a plane layer or, in the case of a two-layer board, a polygon pour on the opposite layer. However, due to the extremely wide traces required to achieve sufficiently low impedances on two-layer PCBs with standard thicknesses (0.5mm and thicker), as well as the likelihood of a GND polygon pour on the layer opposite the RF trace being interrupted, boards with a ground plane are highly recommended.

## Differential RF Path

If very long RF traces are required or the application involves high levels of interference, it may be necessary to convert the Micro-Module RF output from single ended to a differential signal. This can be achieved with an off-the-shelf Balun IC, or using a traditional transformer with a center tap on the secondary (differential side) winding.

Conversion from single ended to differential routing should take place as close to the Micro-Module as the layout allows, so as to reduce the likelihood of interference entering the signal chain in the single ended section.

## Power Supply

The Micro-Module requires a supply voltage of 3.3V or 5V. For optimal performance of the RF front-end, a 5V supply voltage is recommended.

The Micro-Module is fitted with an on-board LDO with a fixed output voltage of 3.3V, which is accessible at Pin 58 (*LDO\_OUT\_3.3V*). The LDO output can be used to supply the microcontroller and digital section of the RF transceiver via pin 59 (*V\_IN\_3.3V*), as well as external devices with low current draw requirements.

Pins 57-60 (*V\_IN\_TRF*, *LDO\_OUT\_3.3V*, *V\_IN\_3.3V* and *LDO\_IN\_5V*, respectively) allow PCB designers to choose an optimal power supply mode. The following supply modes are available:

Supply Modes		Pin connections			
Mode	Description	V_IN_TRF	LDO_OUT_3.3V	V_IN_3.3V	LDO_IN_5V
PSM1	5V supply only, Full-Power RF	Connect to 5V supply	Connect to V_IN_3.3V	Connect to LDO_OUT_3.3V	Connect to 5V supply
PSM2	5V supply only, Reduced-Power RF	Connect to LDO_OUT_3.3V	Connect to V_IN_3.3V & V_IN_TRF	Connect to LDO_OUT_3.3V	Connect to 5V supply
PSM3	3.3V supply only, Reduced-Power RF	Connect to 3.3V supply	Leave floating or tie to GND	Connect to 3.3V supply	Leave floating or tie to GND
PSM4	5V and 3.3V supplied externally, Full-Power-RF	Connect to 5V supply	Leave floating or tie to GND	Connect to 3.3V supply	Leave floating or tie to GND

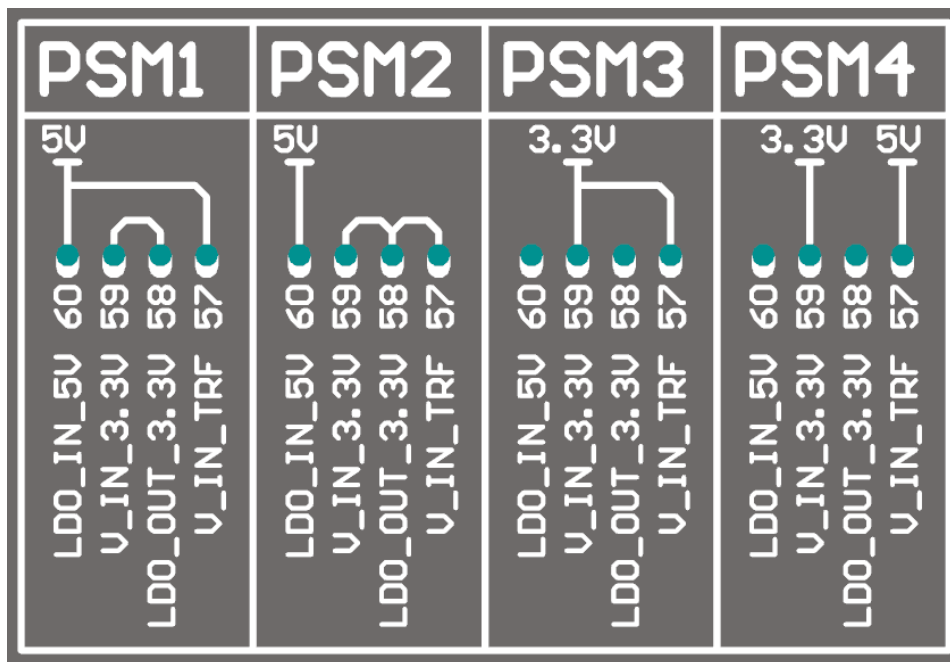

Figure 3: Pin connections for available power supply modes

## USB interface

The Micro-Module provides a full USB2.0 interface for efficient implementation in USB-enabled designs. Standard design principles apply – the usage of TVS diodes and a common mode choke is recommended for optimal reliability and performance.

USB Shield should be connected to PCB GND via a high-value resistor and a small capacitor (1MΩ + 10pF recommended).

For bus-powered applications, VBUS should be decoupled generously and connected to the 5V supply rail using a ferrite bead.

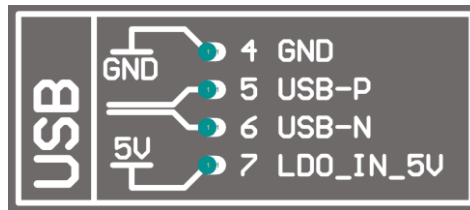

Figure 4: USB section pinout

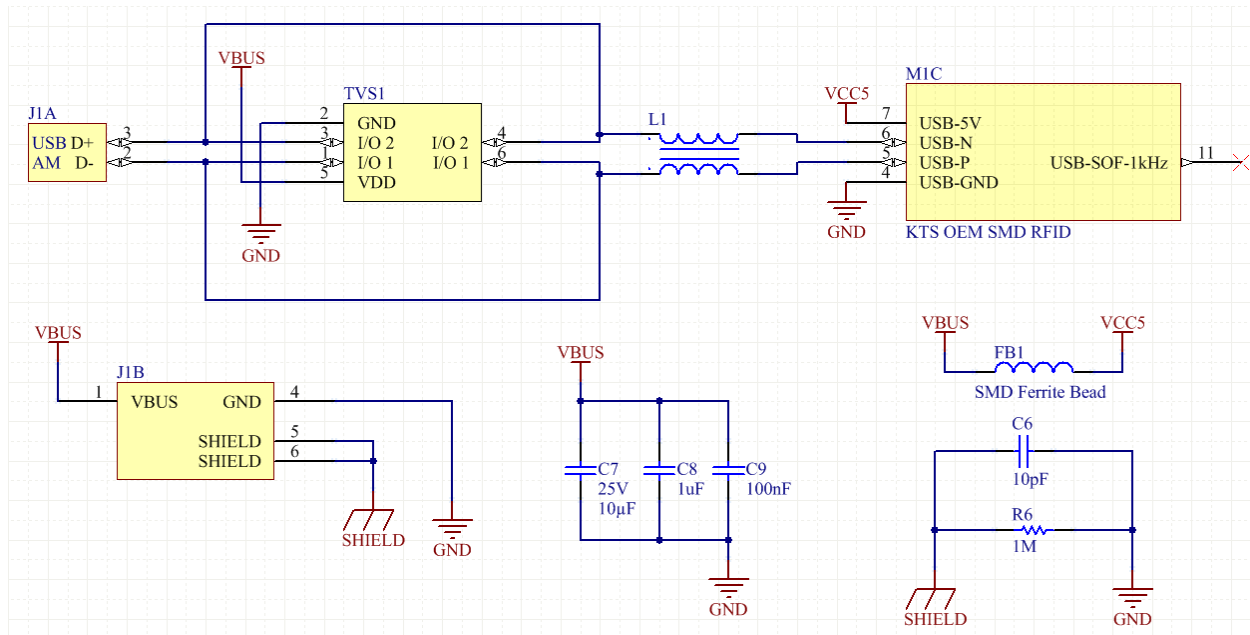

Figure 5: Example Schematic of USB section for standard USB-A connector

## USB Driver

The Micro-Module USB interface is compatible with the standard KTS driver package, available at <http://rfid.kts-systeme.de/downloads/>. The driver package is required for use of USB CDC virtual serial port mode, as well as changing certain configuration parameters via USB.

## USB HID Mode

By default, the Micro-Module is configured in USB HID keyboard emulation mode for simplified transponder reading applications. As soon as the Micro-Module detects a transponder, the UID is entered in any active text field on the host device. Due to widespread standardized support of USB HID devices, no drivers are necessary for HID mode. The Micro-Module can also be used with iOS, Android and other mobile operating systems when set to HID mode.

## USB CDC Mode

For advanced applications, the Micro-Module can be switched to USB CDC virtual serial port mode. This allows full control of the device through the KTS Tag2Image RFID Asset Management System, or via terminal applications such as HTERM using the AT-style command set. See the *AT Command Reference Guide* on <http://rfid.kts-systeme.de/downloads/>.

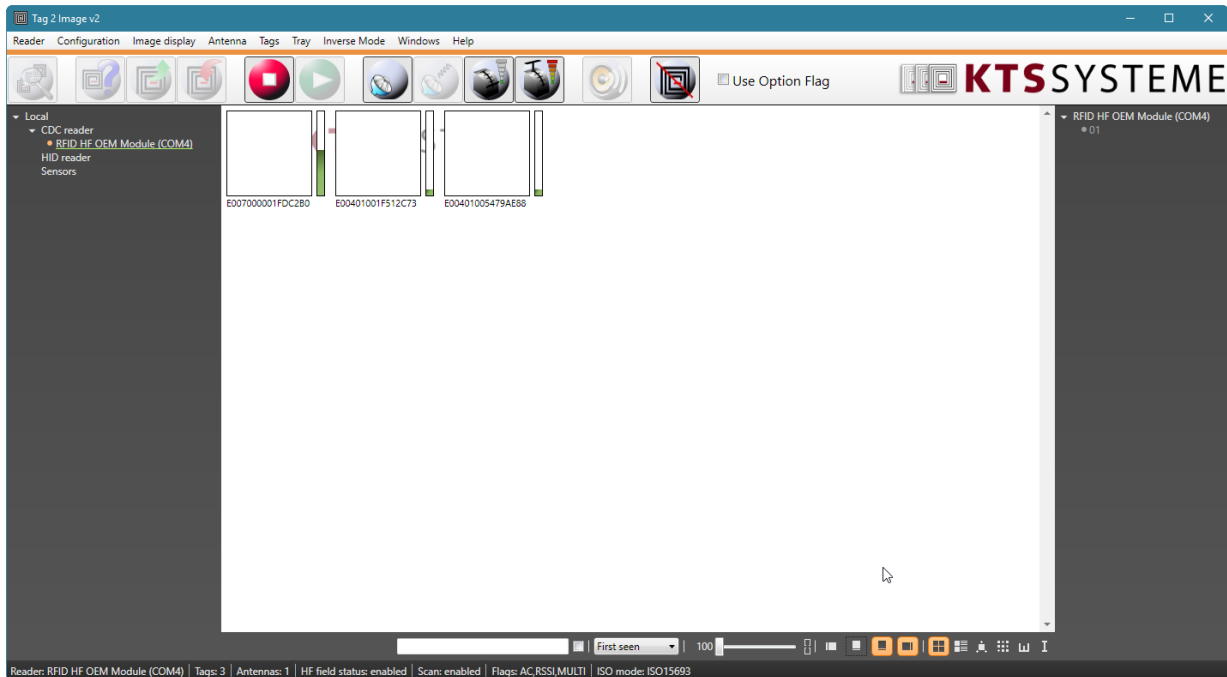

Figure 6: KTS Tag2Image



## UART

The Micro-Module provides a full UART interface with standard 3.3V signalling and optional hardware flow control on Pins 48, 49, 50 and 51 (TXD0, RXD0, RTS0 and CTS0, respectively). If flow control is not required, Pin 50 (*RTS0*) and Pin 51 (*RTS1*) can be left floating.

The UART interface implements the same AT-style command set used for USB CDC virtual serial port mode. See the *AT Command Reference Guide* on <http://rfid.kts-systeme.de/downloads/>. AT commands are identical whether received by UART or USB CDC mode.

## LED Connections

Pins 53, 54 and 55 (*LED\_DATA*, *LED\_TAG* and *LED\_RUN*, respectively) are 3.3V outputs designed for use with low-power signalling LEDs and can drive a current of up to 5mA each. For LEDs requiring higher current, these pins can be used to control MOSFETs or dedicated LED drivers.